

DESCRIPTION

Encapsulated coil incorporating the magnetic circuit.
 Fixing by means of a central nut.
 Electrical connection according to DIN 43650 A.



CONSTRUCTION

Encapsulation:
 Class F Fibre-glass Nylon
 Class H Fibre-glass Polyarylamide
 Magnetic circuit: Zinc-plated steel
 Windings: Copper covered with class H insulation

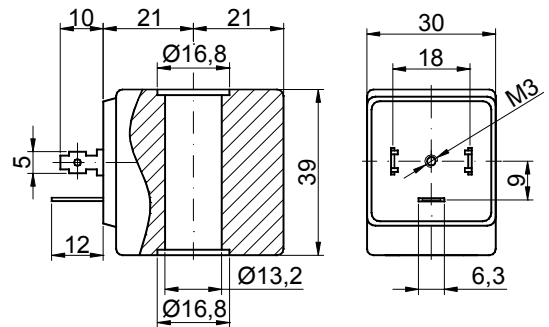

OPTIONS : Electrical connection through cable
 Special powers and voltages
 Self-extinguish

Certified version



CODE		Alternating Current Frequency 50/60Hz Voltage Volt	Direct Current Voltage Volt	Power ①		Voltage tolerance		Connector	Service ED
Insulation class F	Insulation class H			Alternating Current VA	Direct Current Watt	Alternating Current	Direct Current		
20A	22A	12	---	15	10	+15%	±10%	10349000 10349060 10349001	100%
20B	22B	24	---						
20C	22C	48	---						
20D	22D	110	---						
20E	22E	220/230	---			-10%			
20F	22F	240	---						
20G	22G	380	---						
200	220	---	12						
201	221	---	24						
202	222	---	48						
/	U25D	120V 60Hz	cRU US						
/	U25E	230V 60Hz							

① Considering nominal voltage and an ambient temperature of 20°C